

Test & Burn-In Socket, GU22 molded frame series
Size 22x22mm / 0.87x0.87"

0.5mm pitch

0.4mm pitch

10x10 contact max

16x16 contact max

Acceptable device size

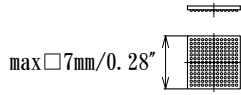

In the case of larger size, consult factory.



How to order

GU22-04P-□□□□□□□□

P/N will be informed after fixing specifications.

04P : 0.40mm pitch
05P : 0.50mm pitch

Features:

- High reliability
- Cost competitive
- Short delivery time
- Temperature -40°C to +150°C

actual size

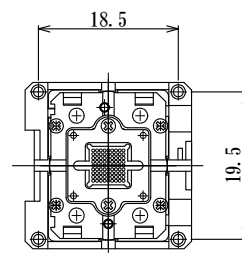
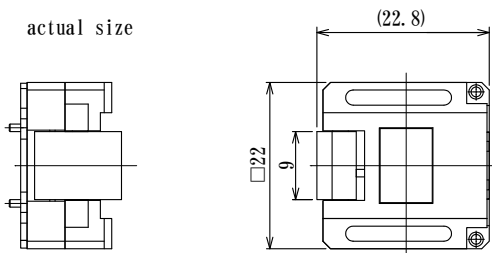

Contact configuration

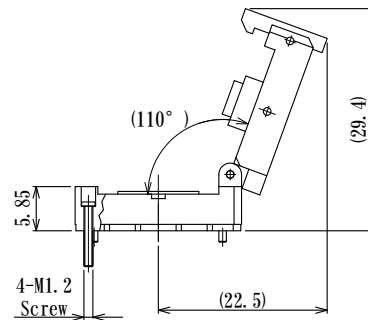
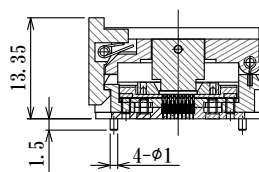
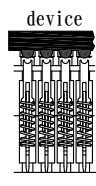

example)

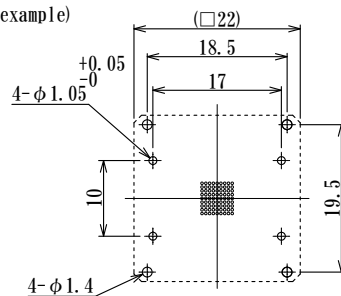

PCB Pattern (Top View)

mm

Two kinds of maximum No. of contact available as below.

0.40mm pitch 16x16 contact max

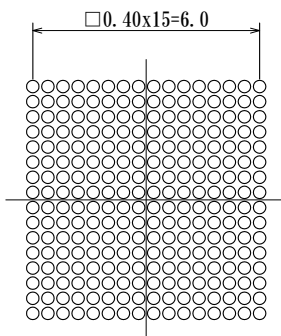

0.50mm pitch 10x10 contact max

