

Test & Burn-In Socket, GQ29 molded frame series  
Size 29x30.6mm / 1.14" x 1.20"

Make to order

Acceptable device size

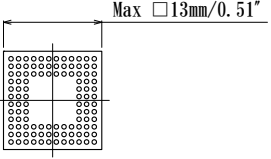

Max □13mm/0.51"

In the case of larger size, consult factory.  
Any device on 0.30mm pitch or larger

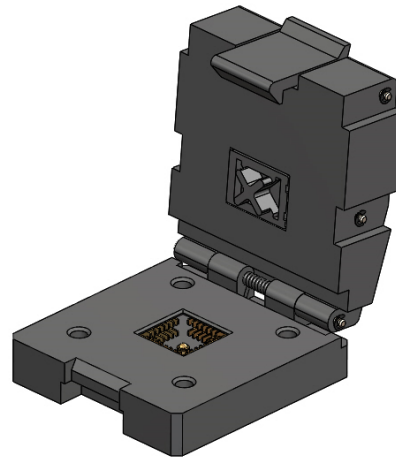

How to order

GQ29-QFN□□□□□□

P/N will be informed after fixing specifications.

example)

Stamping pin socket

actual size

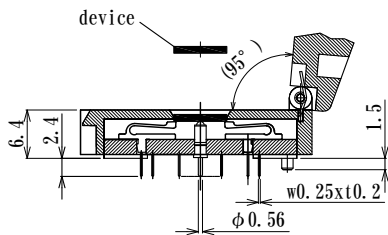
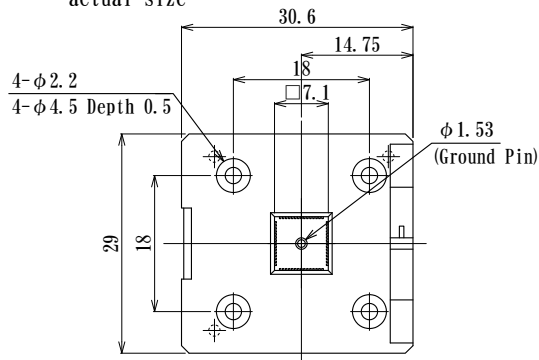

In case QFN Device

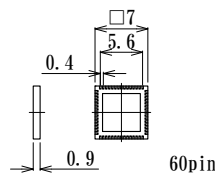

Features:

- High reliability
- Cost competitive
- Short delivery time
- Temperature -40°C to +150°C (typical)

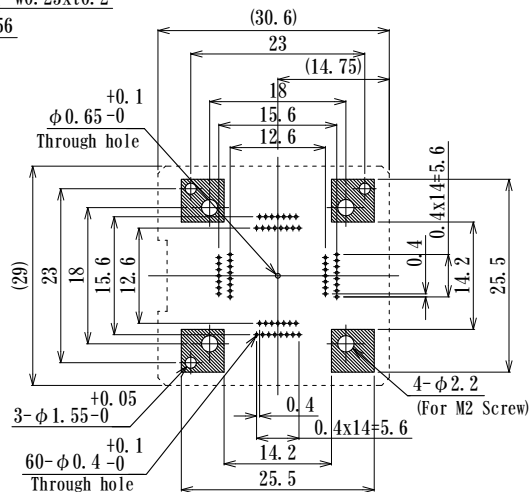
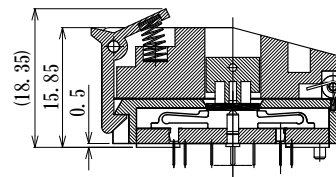
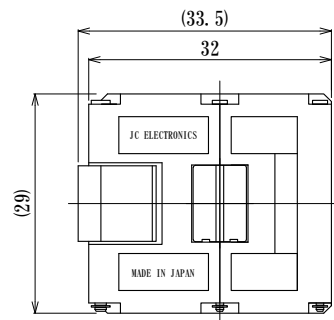

Stand off Area  
PCB Pattern (Top View)

mm

How to order

GQ29-BGA □□□□□□□□

P/N will be informed after fixing specifications.

In case BGA Device

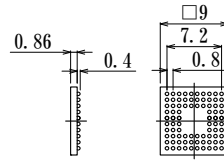

84pin

Features:

- High reliability
- Cost competitive
- Short delivery time
- Temperature -40°C to +150°C (typical)

example)

Probe pin socket  
actual size

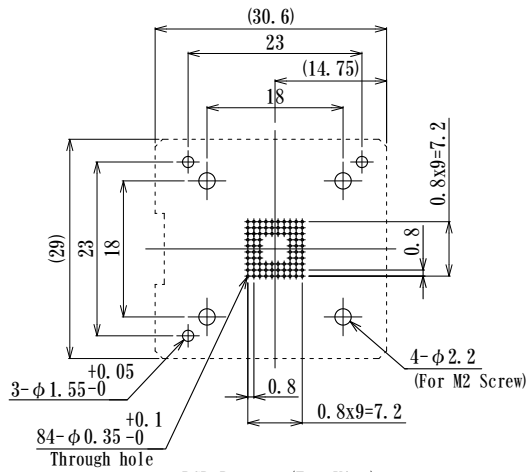
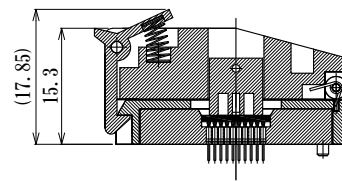
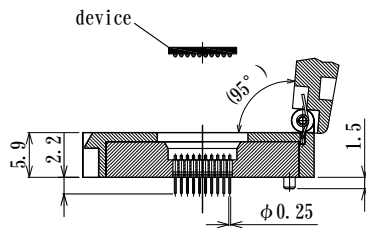
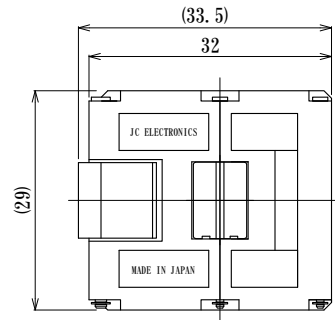
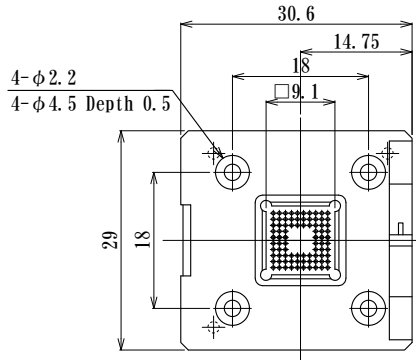

PCB Pattern (Top View)