

Acceptable Plug  $\phi 0.35 \sim \phi 0.21\text{mm}$  , Socket Pins

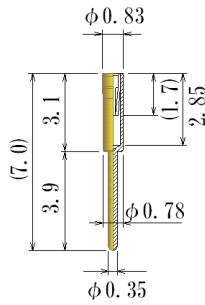

NV6807-GG

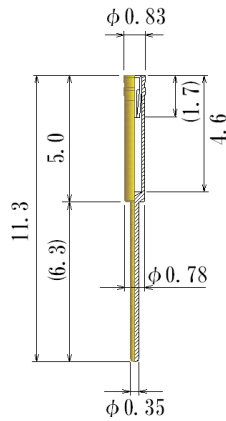

NV6815-GG

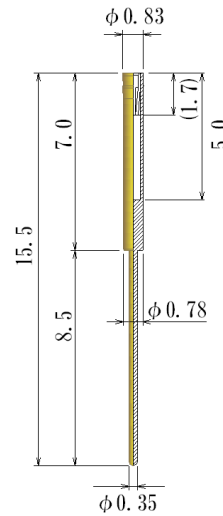

NV6816-GG

(NV6)

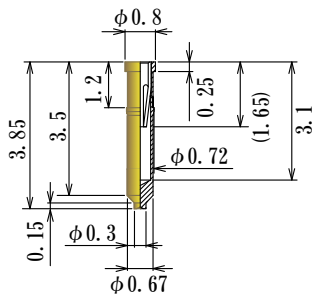

NV6XL385-GG

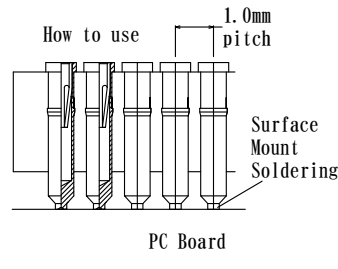

(NV6)

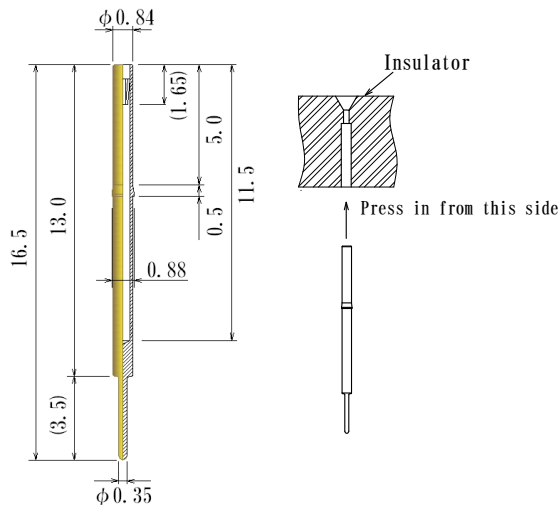

NV6R130L165-GG

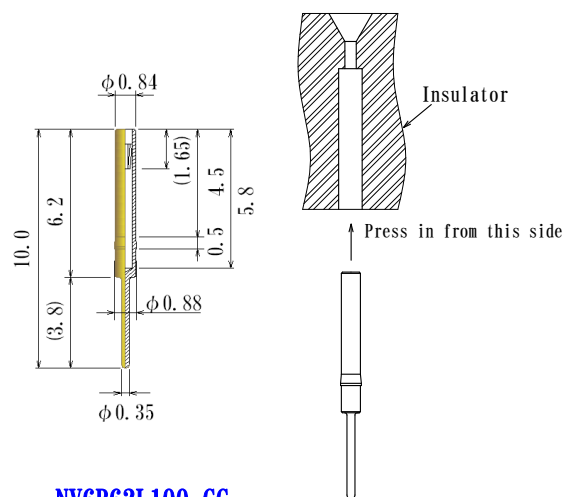

NV6R62L100-GG

(NV6)

Note:

The Pins are for reference only and not for sale.  
Special technique is required to handle these Ultra small Socket Pins.  
Our experienced engineers, to best suit your specifications, will design and assemble your connectors.