

Spring Probe, 8YS series

- [Feature]
- High Durability
 - High Contact Reliability
 - Narrow Pitch type available

The socket fixed method

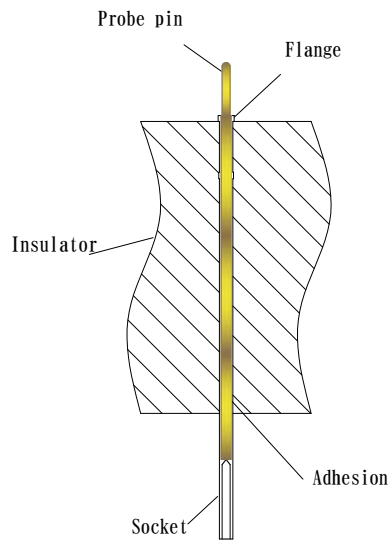

8YSN058 type

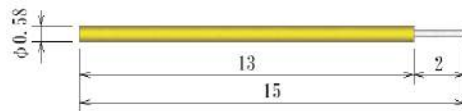

Preload ——— 0.20N (20gf)
2 / 3 travel ——— 0.44N (45gf)
Full travel ——— 0.59N (60gf)

8YSN058-1	8YSN058-2	8YSN058-3	8YSN058-5	8YSN058-5Y
Spherical	Conical	Flat	Crown	Reduced Crown
Material:BeCu Finish:Rh plated	Material:BeCu Finish:Rh plated	Material:BeCu Finish:Rh plated	Material:BeCu Finish:Rh plated	Material:SK Finish:Rh plated

Acceptable Sockets 8YSN058R-F

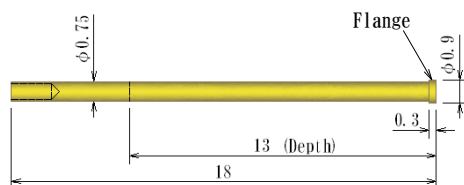

8YSN058R-ST

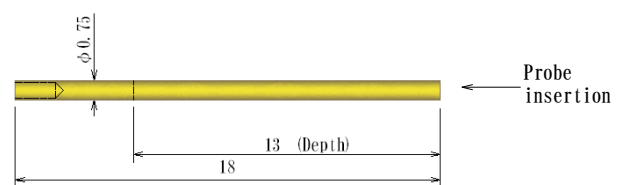

8YSF048 type

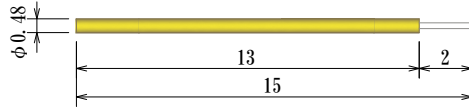

Preload ——— 0.15N (15gf)
2 / 3 travel ——— 0.44N (45gf)
Full travel ——— 0.59N (60gf)

<p>8YSF048-1</p>	<p>8YSF048-2</p>	<p>8YSF048-3</p>	<p>8YSF048-5</p>	<p>8YSF048-5F</p>
-------------------------	-------------------------	-------------------------	-------------------------	--------------------------

Acceptable Sockets

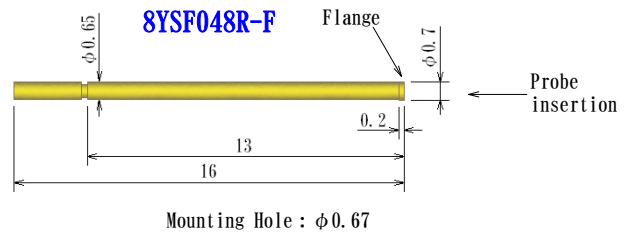
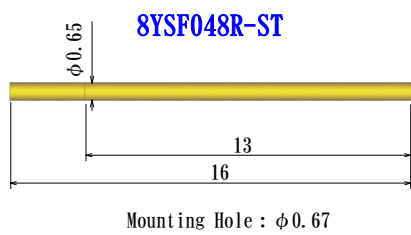

8YSJ038 type

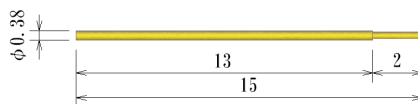

Preload ——— 0.20N (20gf)
2 / 3 travel ——— 0.44N (45gf)
Full travel ——— 0.59N (60gf)

<p>8YSJ038-1</p> <p>Spherical Material: BeCu Finish: Au plated</p>	<p>8YSJ038-2</p> <p>Conical Material: BeCu Finish: Au plated</p>	<p>8YSJ038-3</p> <p>Flat Material: BeCu Finish: Au plated</p>	<p>8YSJ038-5</p> <p>Crown Material: BeCu Finish: Au plated</p>	<p>8YSJ038-5F</p> <p>Reduced Crown Material: SK Finish: Au plated</p>
---	---	--	---	--

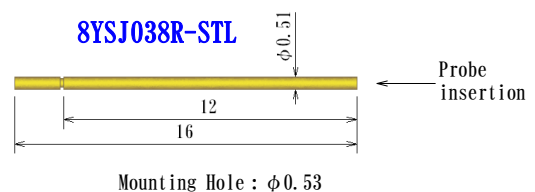
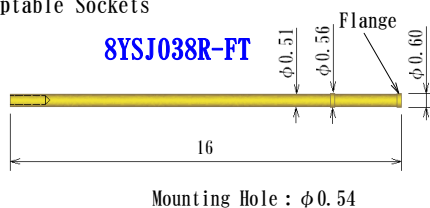

Acceptable Sockets

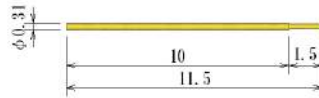

8YSB031 type

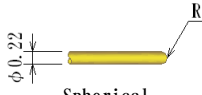

Preload ——— 0.13N (13gf)
2/3 travel — 0.30N (31gf)
Full travel — 0.39N (40gf)

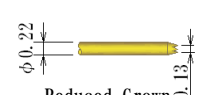
<p>8YSB031-1</p>  <p>Spherical Material:BeCu Finish:Au plated</p>	<p>8YSB031-2</p>  <p>Conical Material:BeCu Finish:Au plated</p>	<p>8YSB031-3</p>  <p>Flat Material:BeCu Finish:Au plated</p>	<p>8YSB031-5F</p>  <p>Reduced Crown Material:SK Finish:Au plated</p>
---	---	---	--

Acceptable Sockets

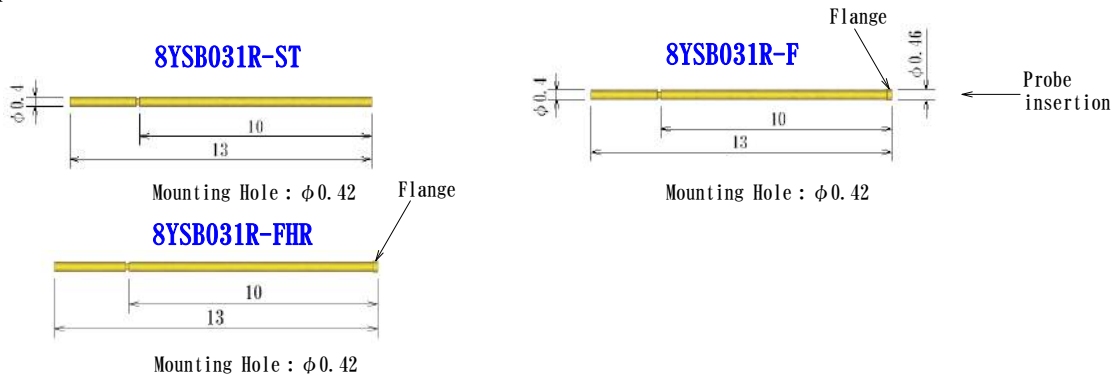

8YSQ025 type

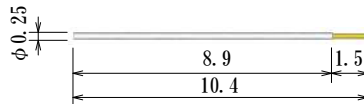

Preload ——— 0.05N (5gf)
1/2travel — 0.18N (18gf)
Full travel — 0.29N (30gf)

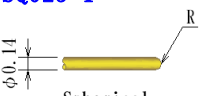
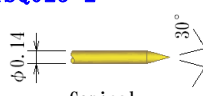
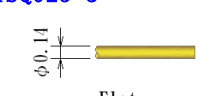
<p>8YSQ025-1</p>  <p>Spherical Material:SK Finish:Au plated</p>	<p>8YSQ025-2</p>  <p>Conical Material:SK Finish:Au plated</p>	<p>8YSQ025-3</p>  <p>Flat Material:SK Finish:Au plated</p>
---	---	---

Acceptable Sockets

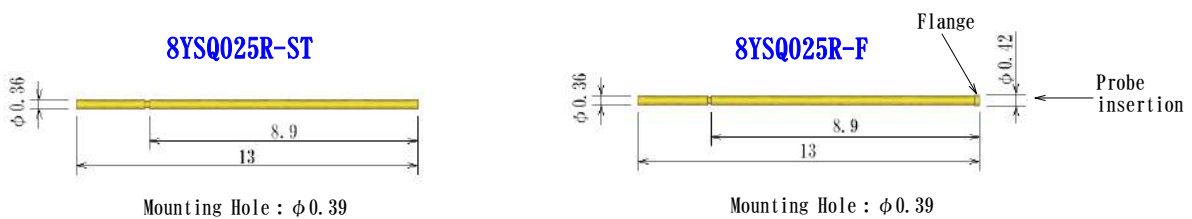

8YSV type

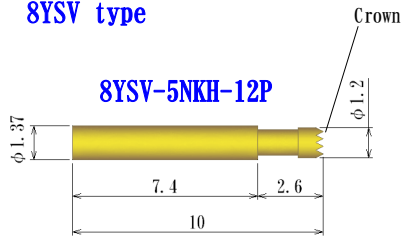

8YSV-5NKH-12P

Preload ——— 0.118N (12gf)
1.1mm travel — 0.696N (71gf)
Full travel — 1.6mm

JR20 type

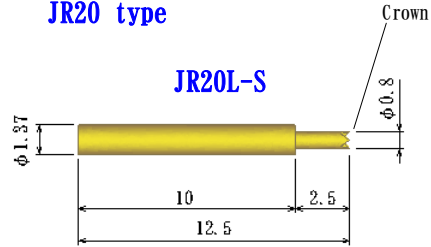

JR20L-S

Preload ——— 0.069N (7gf)
1.5mm travel — 0.39N (40gf)
Full travel — 2.5mm

8YSVR-NKH-LP22

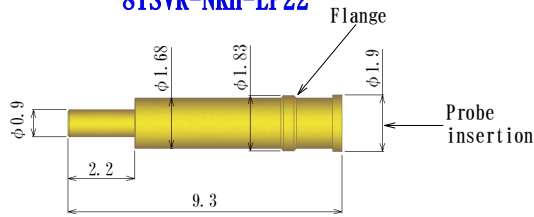

JR20W-S

