

Board to Board High Current Connectors HAHS, HAHP series

5.6mm pitch

25A max

Features:

1. Current rating : 25A max in case of 1 position.
(please refer table below for other number of positions.)
2. Dielectric voltage : AC1800V
3. Each Socket pin and Plug pin protected by mating guide housing insulator.
4. Mating polarization to assure right connection.
5. Two type key position product available. (R type with Black color and L type with Blue color.)
(R type mates only R type. L type mates only L type.)
6. Two $\phi 1.5\text{mm}$ Guidepins to assure proper position to board.

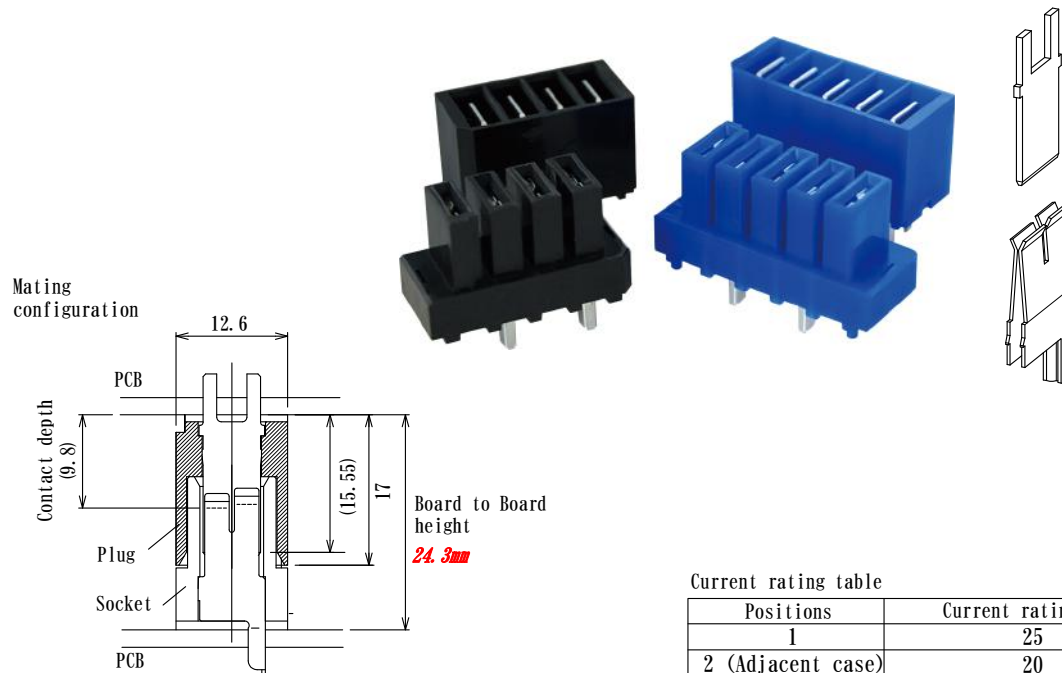

Current rating table

Positions	Current rating [A]
1	25
2 (Adjacent case)	20

Specifications

Current rating	25A at 25°C	
Dielectric withstanding voltage	AC 1800V 1 minute	
Insulation Resistance	1000MΩmin at DC 500V	
Contact Resistance	10mΩ max	
Operating Temperature Range	-25°C~+105°C (including temp. rise by current flow)	
Temperature Range	-55°C~+150°C (in case of new product)	
Mating Holding Force per pin	0.4N (40.8gf)~4.5N (459gf)	
Contact durability	less than 10mΩ after 500 matings	
Material	Insulator	High temperature thermoplastic
	Plug Pin	Copper Alloy Gold plated or Tin plated (Standard Plating)
	Center Socket Contact	Copper Alloy Gold plated or Tin plated (Standard Plating)

Specifications subject to change without notice.

Board to Board High Current Connectors HAHS series, 4 Positions Socket

How to order

HAHS - 04 P R -T

Number of positions
04 : 4 positions

Plating
T : Ni over tin plating
(standard plating)
G : Ni over Au plating

Guide Key position (insulator color)
R : (Black, Standard)
L : (Blue)

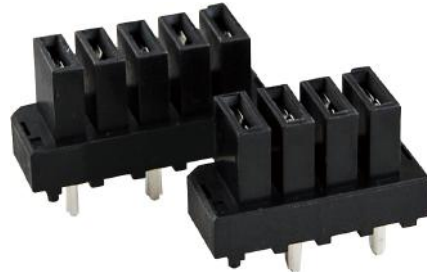

HAHS-04PR-T

(Standard Product)
(Black color)

HAHS-04PL-T

(Blue color)

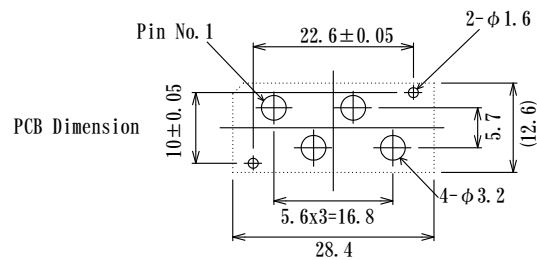
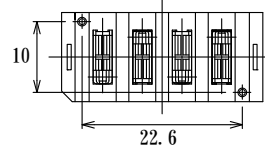
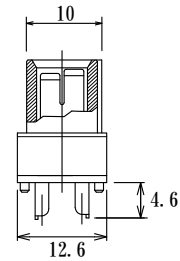
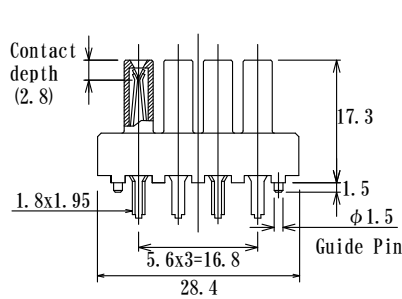
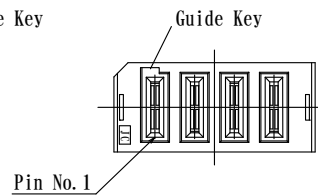
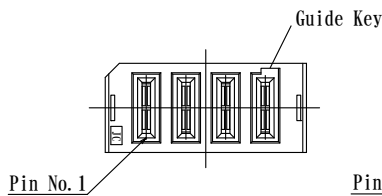

Board to Board High Current Connectors HAHS series, 5 positions Socket

HAHS-05PR-T UL, CSA approved
UL File Number E474715
20A in conformity to UL test guidelines
10A in conformity to CSA test guidelines

How to order

HAHS - 05 P R -T

Number of positions
05 : 5 positions

Plating
T : Ni over tin plating
(standard plating)
G : Ni over Au plating

Guide Key position (insulator color)
R : (Black, Standard)
L : (Blue)

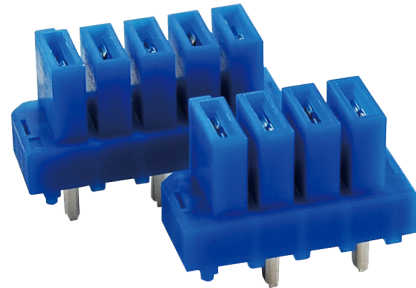

HAHS-05PR-T
(Standard Product)
(Black color)

HAHS-05PL-T
(Blue color)

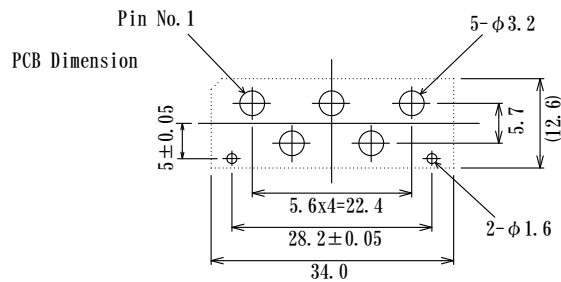
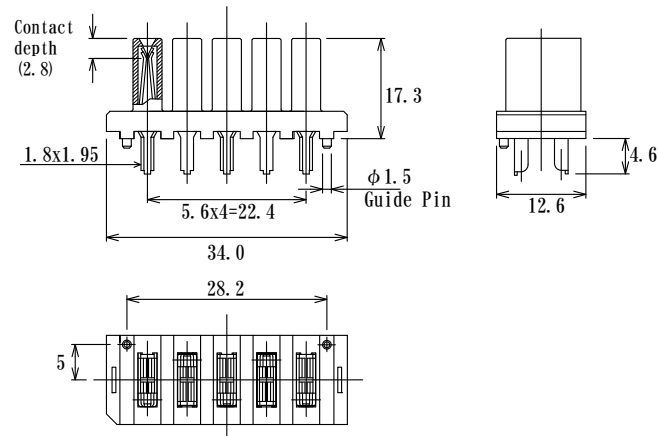
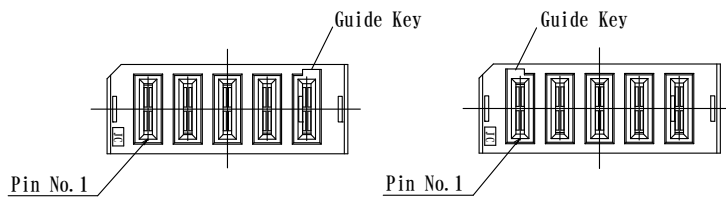

* Black color Socket mates only black color Plug.
* Blue color Socket mates only blue color Plug.

Board to Board High Current Connectors HAHP series, Plug

HAHP-05PR-T UL, CSA approved
UL File Number E474715
20A in conformity to UL test guidelines
10A in conformity to CSA test guidelines

How to order
HAHP - 04 P R - T
Number of positions
04 : 4 positions
05 : 5 positions

Plating
T : Ni over tin plating
(standard plating)
G : Ni over Au plating

Guide Key position (insulator color)
R : (Black, Standard)
L : (Blue)

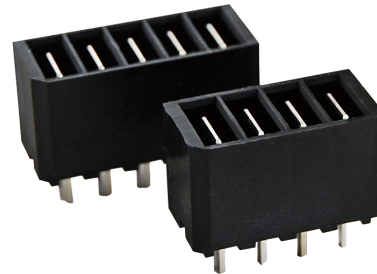

HAHP-04PR-T
HAHP-05PR-T
(Standard Product)
(Black color)

HAHP-04PL-T
HAHP-05PL-T
(Blue color)

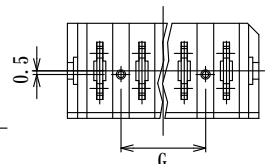
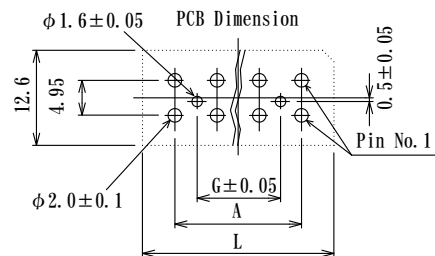
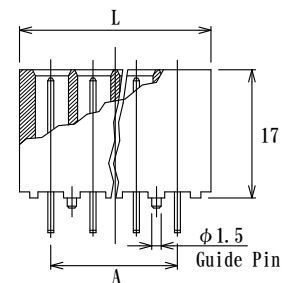
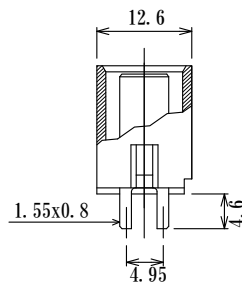
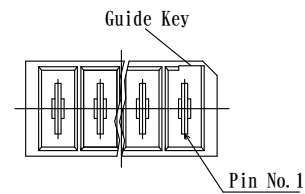
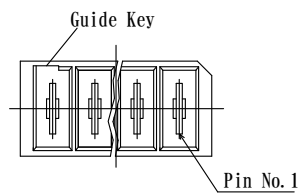

Parts Number	insulator color	No. of positions	A	L	G
HAHP-04PR-T	black	4	5.6x3=16.8	25.4	11.2
HAHP-04PL-T	blue				
HAHP-05PR-T	black	5	5.6x4=22.4	31.0	16.8
HAHP-05PL-T	blue				

* Black color Socket mates only black color Plug.
* Blue color Socket mates only blue color Plug.

Board to Board High Current Connectors HAHS, HAHP series

We welcome your custom design product.
Please contact us.

Example 1 Double height Plug

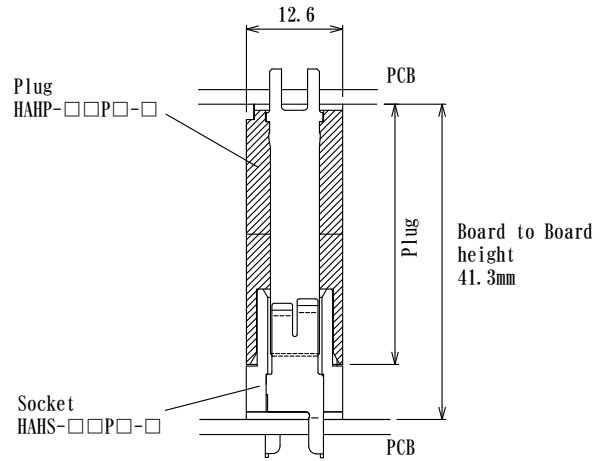

Example 2 Long lead socket pin

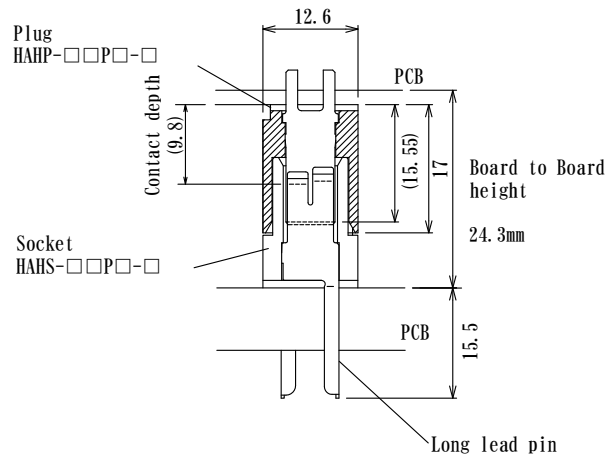

These are examples of custom design products.